

PRODUCT SPECIFICATION 产品规格书

NB25611LM-5

1.6m INTEGRATED BATH
1.6 米浴缸(含裙边/去水)



(Rough-in Dimensions):

安装尺寸图:

(Unit): mm

单位: 毫米

(Size): 1600X700X600

尺寸: 1600X700X600

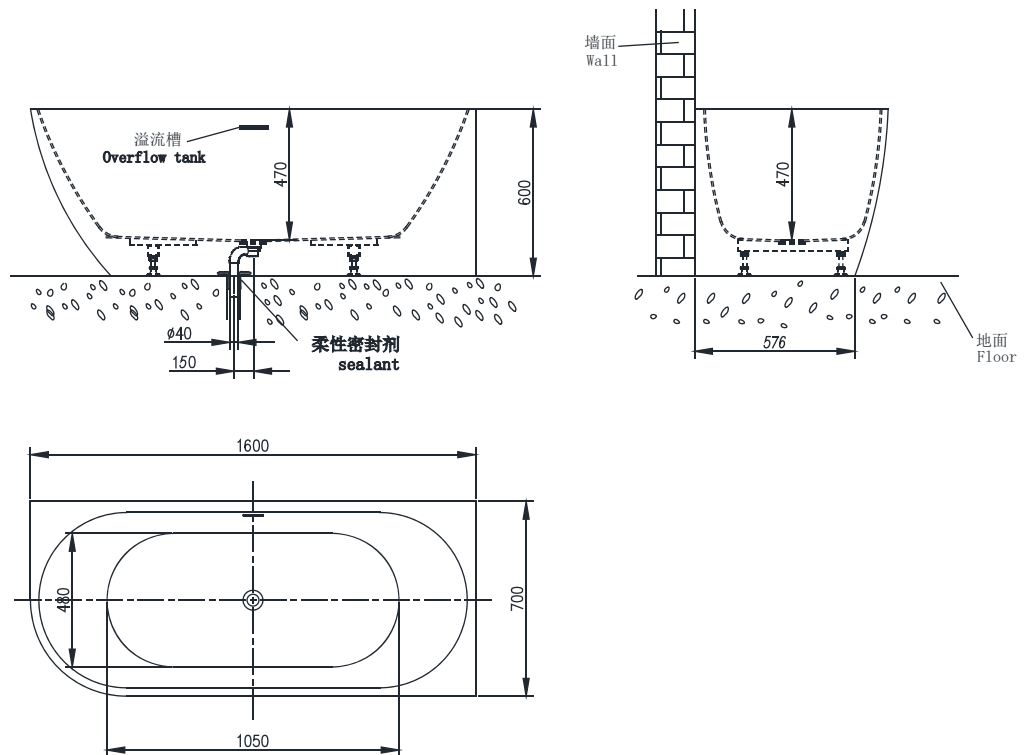

Item No. 品号	NB25611LM-5
Capacity 容水量	Safety volume: 295 L 浴缸安全容水量295升
Available Color 颜色	Matt White 哑光白色
Materials 材质	Acrylic 亚克力
Shipping Package 运输包装	浴缸包装 : L(长)1650 X W(宽) 750X H(高) 650mm (1set/1CTN 1个/1箱) G.W(毛重) : 48kg

Remarks: With overflow function, Contains black copper press bath drain, black overflow grooves and plastic drain pipe. (L=400-1000mm)

备注: 带溢流功能, 包含黑色铜质弹跳去水器, 黑色溢流槽装饰条和塑料排污管(L=400-1000mm)。

INNOCI reserves the right to make changes or modifications on any of its products without advance notice.
INNOCI 艺耐公司保留不事先通知便改变或修改的权利

innoci

Innoci Sanitary ware Co.,Ltd
www.innoci.com

Version:A0

版本:A0